

Kare Tavan Difüzörleri (Kare Anemostatları)

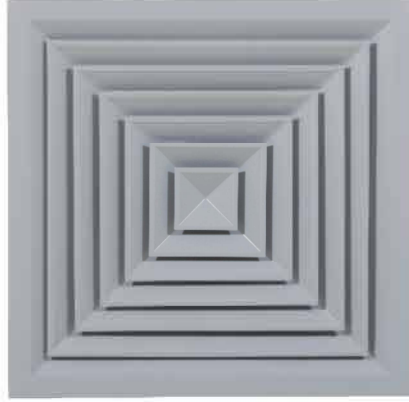

“ IKA ” Modeli

CEES IKA modeli kare tavan difüzörleri özel gekilmiş alüminyum profillerden imal edilmektedir. Tek, iki, üç veya dört One Liflemeli olarak imal edilirler. Kare tavan difüzörleri dampersiz veya çif kanatlı debi reglaj damperli olarak imal edilirler. Dampersiz difüzörleri plenum kutulu olarakda üretmek mümkündür. Metre talebine bağlı olarak üstten veya yandan giriş plenum kutulu, izoleli veya izolesiz olarak yapılırlar. Standart renk RAL 9010 ve RAL 9016 fırınlanmi elektostatik toz olup metre talebine göre değişik renkler de uygula-nabilir.

Ölçüler

Düz Kanatlı Modeller

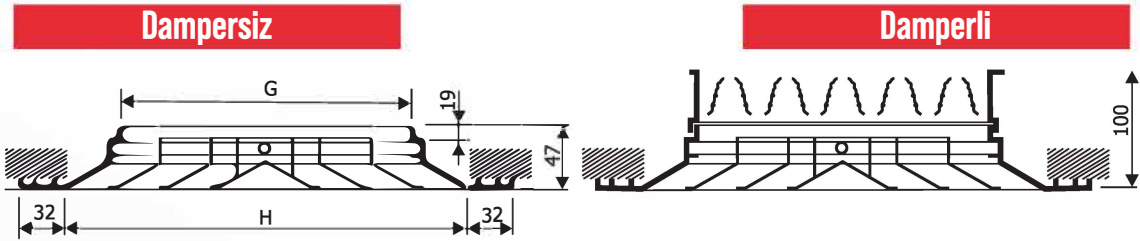

Eğik Kanatlı Modeller

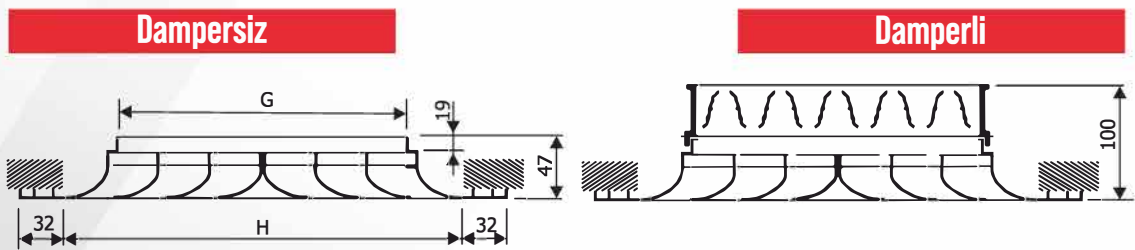

Kare Tavan Difüzörleri (Kare Anemostatları)

Alternatif

Sökülebilir göbekli
Her iki model için geçerlidir

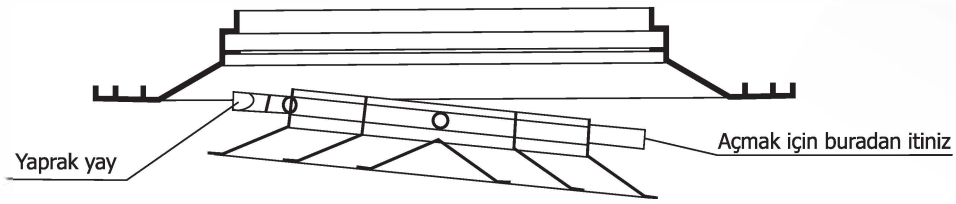

MODEL	IKA--- 150X150	IKA--- 225X225	IKA--- 300X300	IKA--- 375X375	IKA--- 450X450	IKA--- 525X525	IKA--- 600X600
G (mm)	150	225	300	375	450	525	600
H (mm)	226	301	376	451	526	601	676

Üfleme Alternatifleri

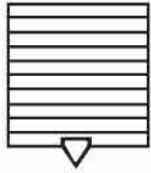

IKA1

Tek yöne üflemleri

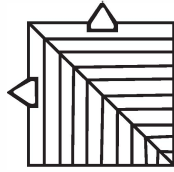

IKA2

İki yöne üflemleri



IKA5

İki yöne üflemleri

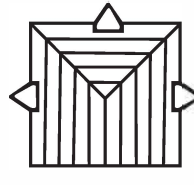

IKA3

Üç yöne üflemleri

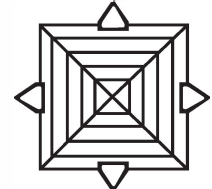

IKA4

Dört yöne üflemleri

Özel Kare Tavan Difüzör Modelleri



KAROLAJ VE ALÇIPAN
TAVAN MODELİ DİFÜZÖR



SARKMA ASMA TAVAN
MODELİ DİFÜZÖR



CLIP-IN SİSTEM DİFÜZÖR

Kare Tavan Difüzörleri (Kare Anemostatları)

Seçim Tablosu-1

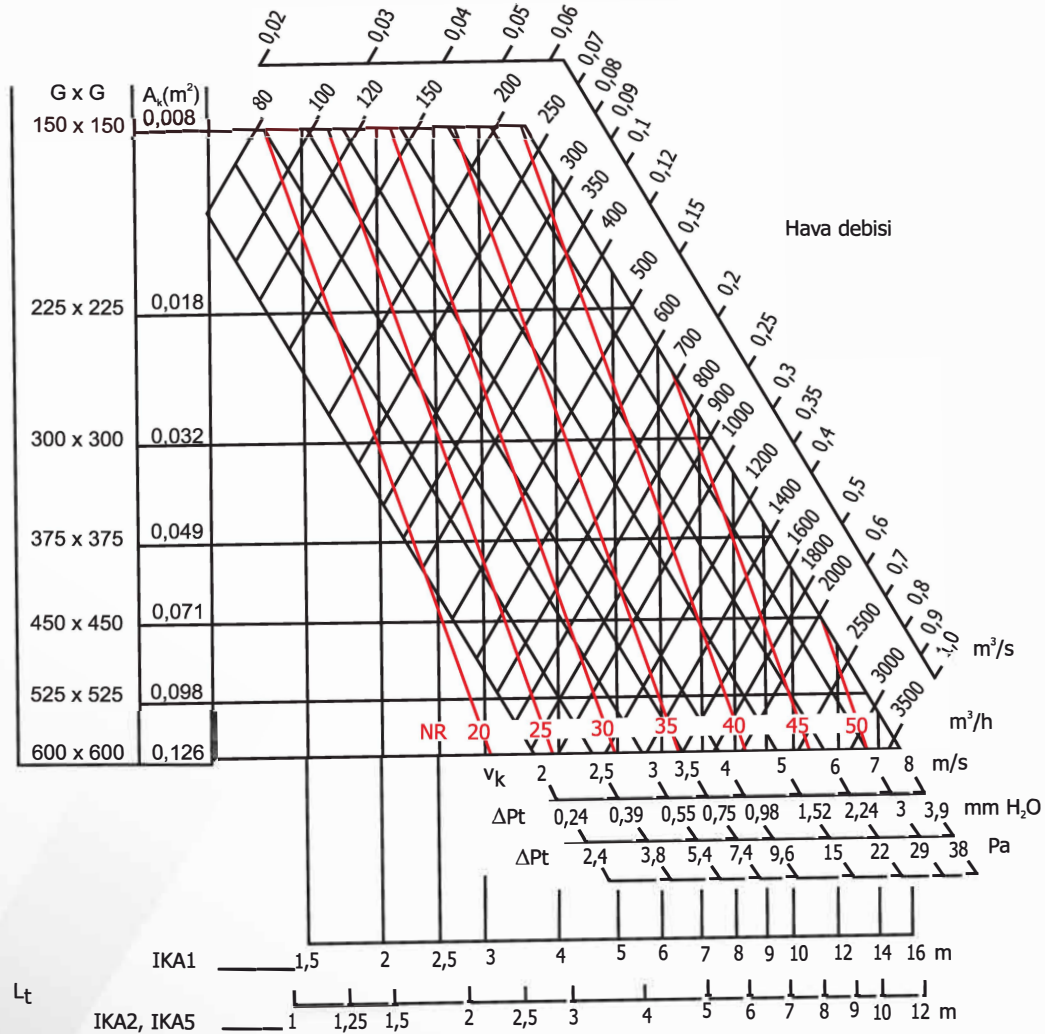

Düzeltilme faktörleri

Vt (m/s)	0,25	0,5	0,75	1
Lt	x1,63	x1,00	x0,67	x0,50

Kare Tavan Difüzörleri (Kare Anemostatları)

Seçim Tablosu-2

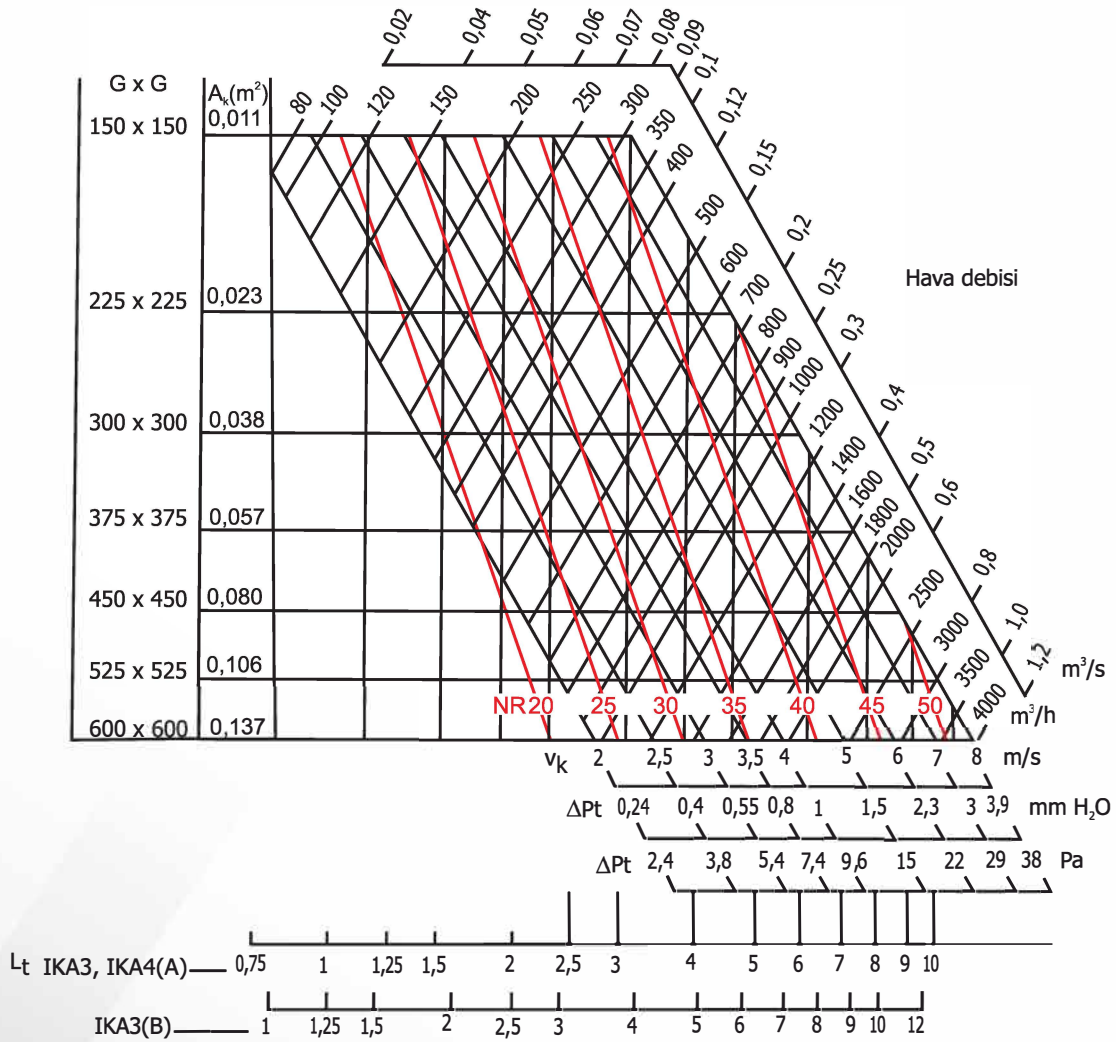
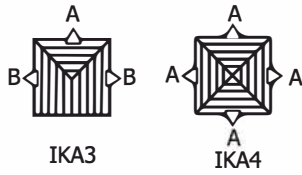

Düzeltilme faktörleri

V _t (m/s)	0,25	0,5	0,75	1
L _t	x1,63	x1,00	x0,67	x0,50

Kare Tavan Difüzörleri (Kare Anemostatları)

Ölçüler

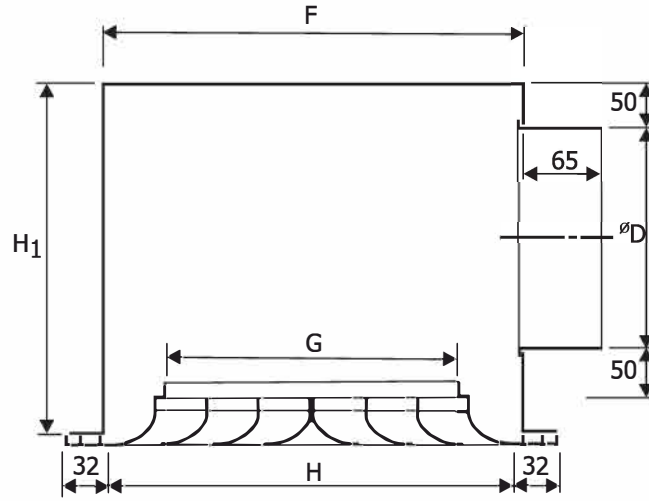

Yandan Girişli

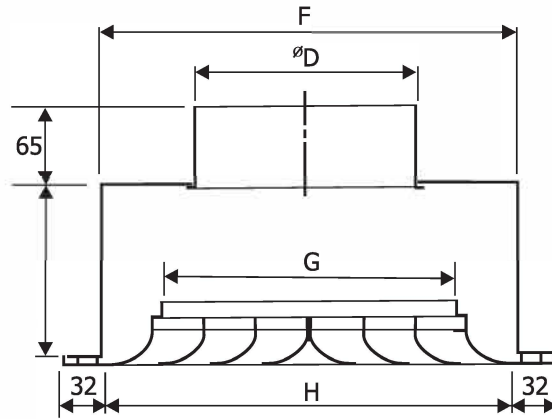

Üstten Girişli

Not: Talep üzerine değişik giriş çapları mümkündür.

MODEL	IKA---150x150	IKA---225x225	IKA---300x300	IKA---375x375	IKA---450x450	IKA---525x525	IKA---600x600
F (mm)	240	315	390	465	540	615	690
H1 (mm)	250	300	380	455	500	600	660
H2 (mm)	150	200	280	355	400	500	560
ØD (mm)	150	200	280	355	400	500	560

Kare Tavan Difüzörleri (Kare Anemostatları)

Sipariş Notasyonu

IKA4-D-150x150+PSI125kl

